

Type : 3EL160M2C-PA-BA-000

Date : 01.01.2023

Power [kW]	: 15.0	Efficiency Class	: IE3
Input Voltage [V]	: 400	Duty Cycle	: S1
Connection Type [Δ / Y]	: Δ	Service Factor	: 1.20
Frequency [Hz]	: 50	Frame Size	: 160M
Pole Number	: 2	Weight [kg]	: 87.8
Nominal Speed [rpm]	: 2950	Insulation Class	: F [155°C]
Nominal Current [A]	: 26.5	Temperature Rise	: B [80°K]
Nominal Moment [Nm]	: 48.6	Protection Class	: IP55
Nominal Efficiency [η]	: 91.9	Vibration Severity Grade	: A
Power Factor [cosφ]	: 0.89	Method of Cooling	: IC411 (TEFC)
Locked Rotor Current [Ia/In]	: 8.9	Direction of Rotation	: Bidirectional
Locked Rotor Torque [Ma/Mn]	: 3.1	Balance	: Half Key
Breakdown Torque [Mk/Mn]	: 4.2	Motor Thermal Protection	: PTC
Motor Color	: RAL 7031	Altitude Above Sea Level	: 1000m
Ambient Temperature	: -15°C / +40°C	Sound Pressure Level [dBA]	: 69

ELECTRICAL DATA

Δ / Y	U [V]	f [Hz]	P [kW]	n [rpm]	I [A]	η [%100]	η [%75]	η [%50]	Cosφ	Cl
Δ	400	50	15.0	2950	26.5	91.9	92.1	91.6	0.89	IE3
Y	690	50	15.0	2950	15.3	91.9	92.1	91.6	0.89	IE3
Δ	460	60	15.0	3545	23.1	91.8	92.0	91.5	0.89	IE3
Δ	460	60	17.4	3540	26.4	92.0	92.2	91.7	0.90	IE3

MECHANICAL DATA

Moment of Inertia [kgm ²]	: 0.03913
Bearing [DS / NS]	: 6309ZZ / 6209ZZ
Frame Material	: Aluminum
Flange Type / Material	: B5 / Aluminum
Cooling Fan Material	: Plastic
End Shield Material	: Aluminum

TERMINAL BOX

Terminal Box Material	: Aluminum
Terminal Box Position	: Top
Terminal Box Cable Entry	: 2xM32x1.5
Terminal Box Blind Cap	: --
Contact Screw Thread	: M6

MECHANICAL DIMENSIONS

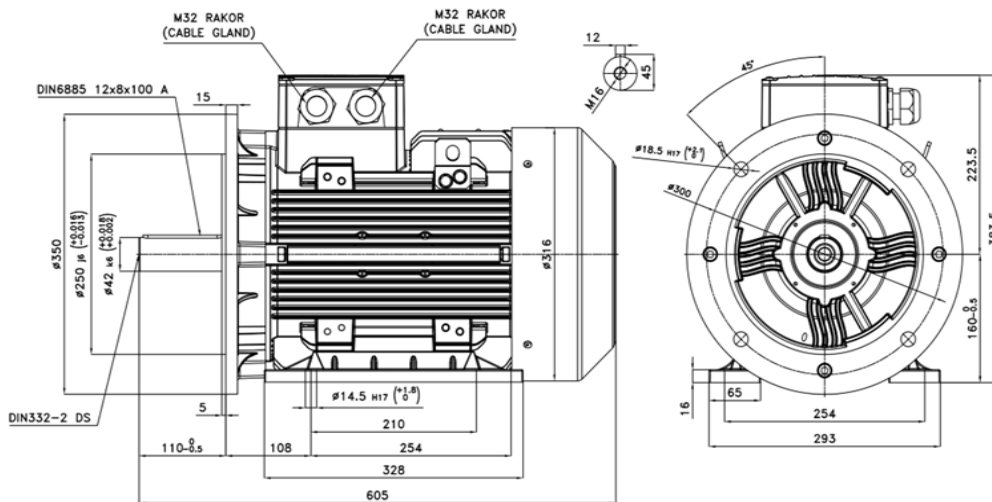

Manufactured and tested in accordance with IEC 60034

*Technical data are subject to change! There may be discrepancies between calculated and rating plate values.

*ELK Motor has right to change all the data without prior notice.

FR.AG.010 REV.NO: 04 REV.DATE: 01.01.2023



ELK MOTOR SAN. ve TİC. A.Ş.
www.elkmotor.com.tr
+90 (282) 726 92 94

TECHNICAL DATASHEET ACCORDING TO COMMISSION REGULATION (EU) 2019/1781 THREE PHASE INDUCTION MOTOR - SQUIRREL CAGE

Type : 3EL160M2C-PA-BA-000

Date : 01.01.2023

NAMEPLATE DATA

Power [kW]	: 15.0	Nominal Speed [rpm]	: 2950
Nominal Voltage [V]	: 400	Nominal Current [A]	: 26.5
Connection Type [Δ / Y]	: Δ	Nominal Moment [Nm]	: 48.6
Nominal Frequency [Hz]	: 50	Nominal Efficiency [η %]	: 91.9

THE POWER LOSSES AT SEVEN OPERATING POINTS ACCORDING TO COMMISSION REGULATION (EU) 2019/1781

Operating Point Number	Speed n/n_N [%]	Torque T/T_N [%]	Relative Power Losses P_L/P_N [%]	Efficiency η [%]
P ₁	90	100	7.3	92.6
P ₂	50	100	5.4	90.2
P ₃	25	100	5.0	83.3
P ₄	90	50	4.7	90.6
P ₅	50	50	2.6	90.4
P ₆	50	25	2.0	86.3
P ₇	25	25	1.1	84.9

MAP OF RELATIVE POWER LOSSES P_L/P_N [%]

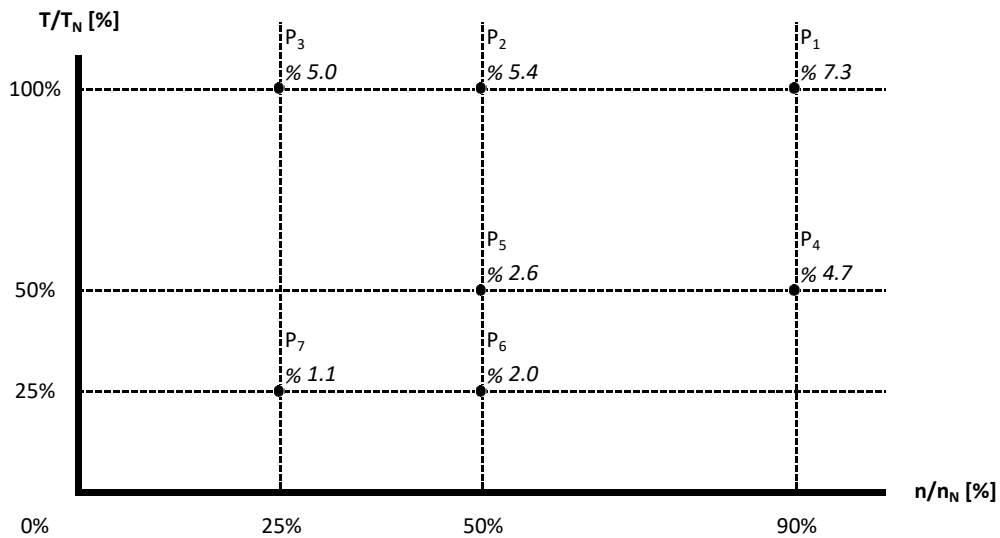

Manufactured and tested in accordance with IEC 60034

FR.AG.010 REV.NO: 04 REV.DATE: 01.01.2023

*Technical data are subject to change! There may be discrepancies between calculated and rating plate values.

*ELK Motor has right to change all the data without prior notice.

Motor Code : 3EL160M2C-PA-BA-000

Torque and Current Curves Related to Speed

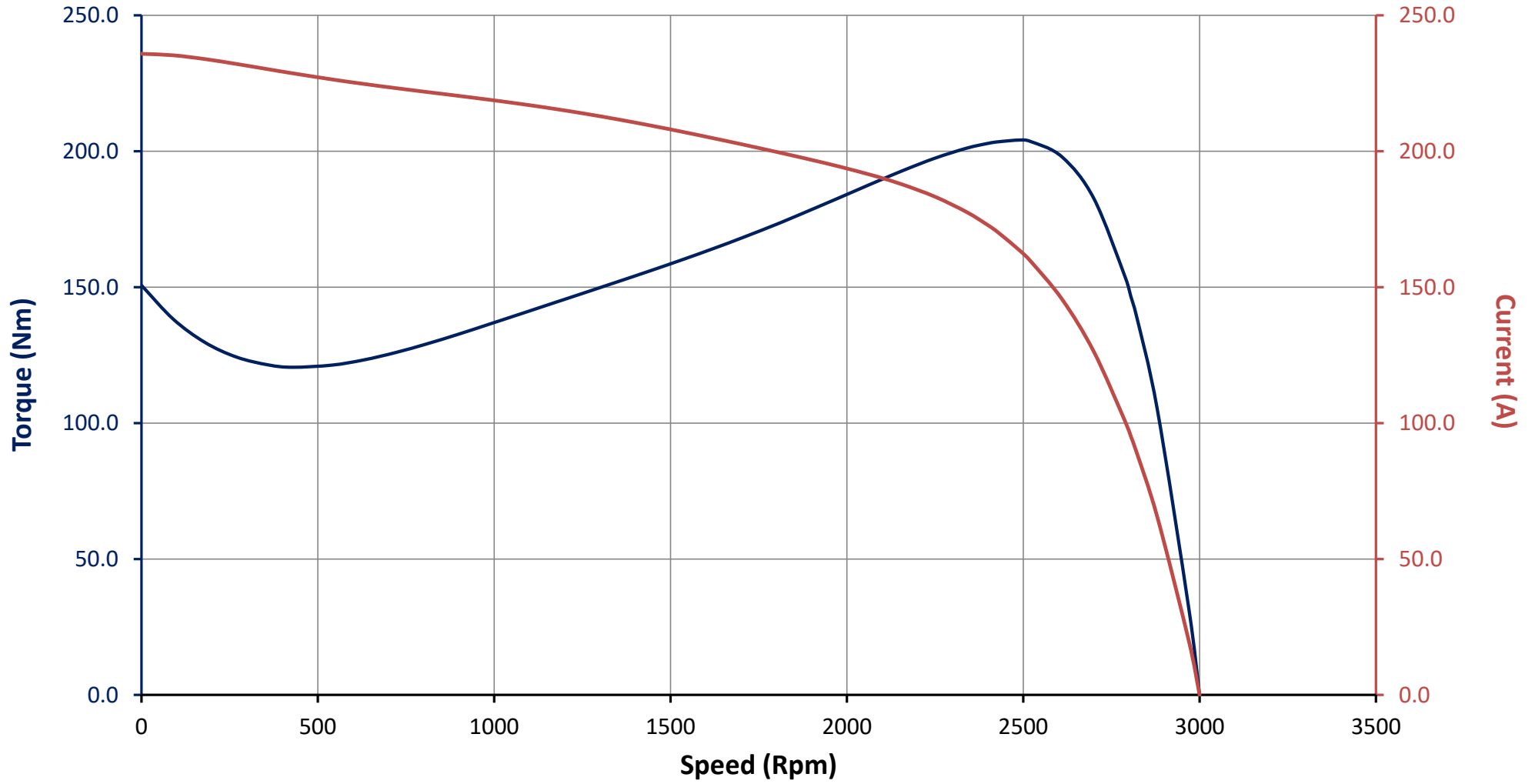

Motor Code : 3EL160M2C-PA-BA-000

Performance Curves Related to Rated Output

